

**Installation of Trampoline
TQ1013**

Precautions for Use:

- 1) The equipment is only applicable to gymnastic activities. The equipment should be used under the guidance and supervision of professionals, and those without gymnastic experience should be used with caution;
- 2) Children under 10 years of age are prohibited from using it;
- 3) The equipment shall not be used by more than one person at the same time, with a maximum load of 300Kg;
- 4) The equipment shall only be used indoors, and the safe area shall be no less than 15000mm×7500mm, and the venue height shall be no less than 12000mm;
- 5) Special protective pads shall be installed before the equipment is used;
- 6) Before using the equipment, check whether all parts of the equipment are in good condition and firmly locked. If not, it should not be used;
- 7) If abnormal sound occurs during the use of the equipment and obvious parts become loose, the equipment should be stopped immediately;
- 8) After the equipment is adjusted, ensure that the equipment is properly adjusted and firmly locked before use;
- 9) It is strictly prohibited to adjust the equipment during use;
- 10) Warm up adequately to prevent injuries before using the equipment. If you feel obvious pain or discomfort during the use, please do not continue to use to avoid further injury;
- 11) Do not use heavy objects to hit the surface of the equipment or sharp objects to

scratch the equipment;

12) Do not wipe the metal coating surface of the equipment with liquids other than neutral detergent and water;

13) Do not use any appliance other than a vacuum cleaner to clean the surface of the protective cushion. Pay attention to moistureproof and waterproof when cleaning;

14) Do not place heavy objects (such as benches, tables and chairs) on the surface of the equipment for a long time;

15) The trampoline protection pad is made of multiple pads, which may produce color difference. Slight color difference is normal;

16) The spring is a fragile part and may break during use, which is a normal phenomenon;

17)When using, please pay attention to operate according to the warning mark on the product label.

Product introduction

This product can be used in trampoline training and competition.The equipment is equipped with safety protection pad for high safety;The bed leg is fixed with high strength drawstring, which is easy to adjust.The equipment can be folded and stored to save space;High safety and stability of equipment, high elasticity of net surface, can meet the professional needs of training and competition.A trampoline consists of a protective covering, a side bed, a main bed, and a

trampoline transport vehicle (see Figure 1).

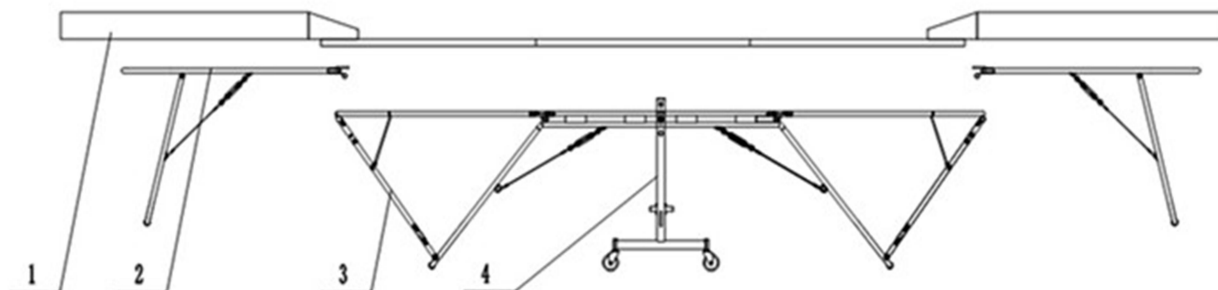

1- Protective pad;2 - vice bed;3 - master bed;4- Trampoline transporter

Product parameters:

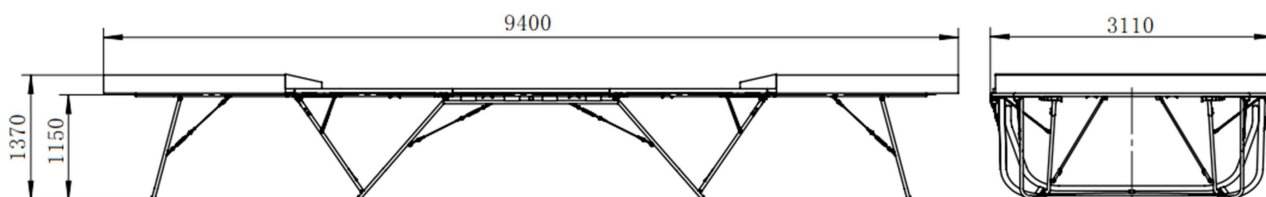

- 1) The overall specification is 9400mm×3110mm×1370mm;
- 2) The screen size is 4240mm×2120mm;
- 3) The height of the screen is 1150mm;
- 4) The spring part has 8 large springs and 110 middle springs;
- 5) Main bed specification: 5180mm×3110mm×1170mm;
- 6) Protection pad: 9400×3050cm×200cm.

Installation instructions:

Packing list:

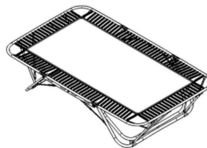
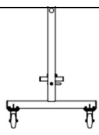
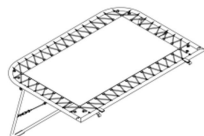
<p>Size 3000×2000 ×200 1- Protect mat 1 2</p>	<p>Size 3000×400× 160 2- Protect mat 2 2</p>	<p>Size 2010×520× 50 3- Protect mat 3 2</p>	<p>Size 1730×520× 50 4- Protect mat 4 2</p>	<p>Size 1730×520× 50 5- Protect mat 5 2</p>
<p>Size 1730×520× 50 6- Protect mat 6 2</p>	 <p>7-main bed 1</p>	 <p>8- Trampoline transporter 1</p>	 <p>9-auxiliary bed 2</p>	<p>10-main bed cover 1</p>
<p>11 -tools bag 1</p>				

Installation steps:

1) Move the equipment to a flat and spacious area for use. The ground shall be flat for use. The fulcrum shall bear a static load of 5000N without deformation,

and add 4 support plates if necessary.

2) As shown in Figure 3, expand the main bed from the folded state to the flat area and remove the 8-trampoline transport

Car, adjust the height of trampoline, connect the auxiliary bed through the bolt pipe carried by the main bed, make it a whole.

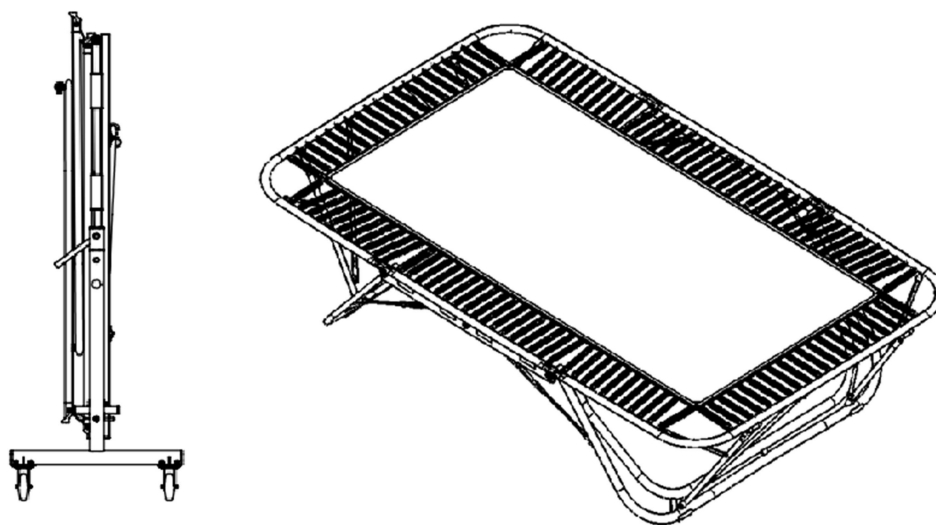

Fold (including trampoline trolley) unroll

3) Installation of protection pad: As shown in FIG. 4, 1-Protection pad 1;2- Protection pad 2;3- Protective pad 3;4- Protective pad 4;5- Protection pad 5;6- Protective pad 6 is arranged neatly and connected to the main bed with adhesive buttons.

Description: 1- Protective pad 1;2- Protection pad 2;3- Protective pad 3;4-

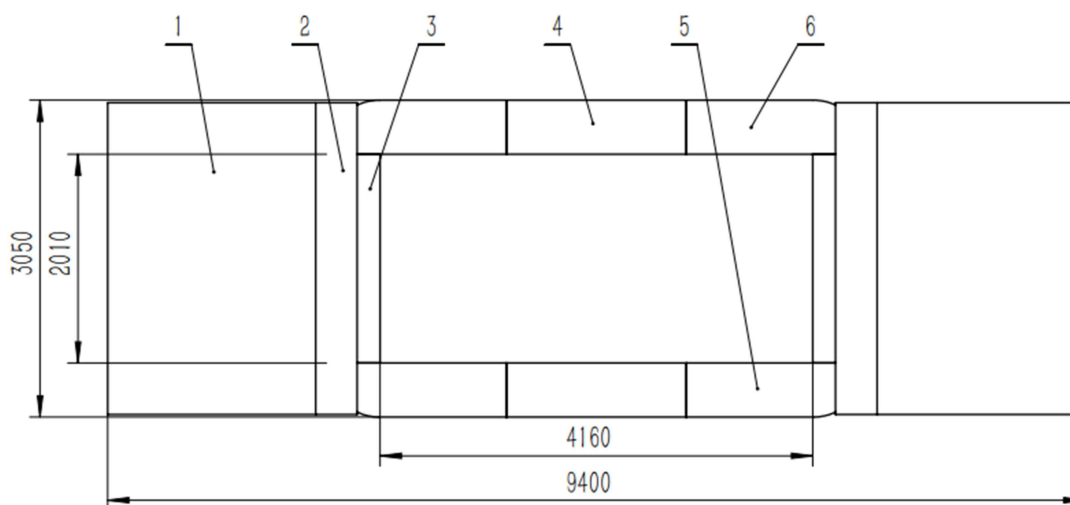

Protective pad 4;5- Protection pad 5;6- Protection pad 6

Directions for use:

This product is designed for trampoline training and competition.

Maintenance:

1. During the use of the trampoline, it is necessary to check regularly whether all the connecting parts of the product are loose or fall off, and tighten or replace them in time after finding out, so as to ensure the safety of use.
2. When there are stains on the surface of the equipment, vacuum cleaner can be used to clean it.
3. After one year of use, it is recommended to use the product after professional inspection.

Quality guarantee

1. The product warranty period is 1 year from delivery.
2. Product quality problems caused by improper use and improper

maintenance shall be borne by the users themselves.

3. Surface damage of equipment caused by scratch or knock is not covered by the warranty.
4. Beyond the warranty period, the product provides free technical support services and paid on-site maintenance services.